

**SECTION A**

Q. No.	(a)	(b)	(c)	(d)	Q. No.	(a)	(b)	(c)	(d)
1	<input type="checkbox"/>	<input type="checkbox"/>	<input type="checkbox"/>	<input checked="" type="checkbox"/>	16	<input checked="" type="checkbox"/>	<input type="checkbox"/>	<input type="checkbox"/>	<input type="checkbox"/>
2	<input type="checkbox"/>	<input checked="" type="checkbox"/>	<input type="checkbox"/>	<input type="checkbox"/>	17	Question dropped			
3	<input type="checkbox"/>	<input type="checkbox"/>	<input checked="" type="checkbox"/>	<input type="checkbox"/>	18	<input type="checkbox"/>	<input type="checkbox"/>	<input type="checkbox"/>	<input checked="" type="checkbox"/>
4	<input type="checkbox"/>	<input type="checkbox"/>	<input type="checkbox"/>	<input checked="" type="checkbox"/>	19	<input type="checkbox"/>	<input checked="" type="checkbox"/>	<input type="checkbox"/>	<input type="checkbox"/>
5	<input type="checkbox"/>	<input type="checkbox"/>	<input checked="" type="checkbox"/>	<input type="checkbox"/>	20	<input type="checkbox"/>	<input checked="" type="checkbox"/>	<input type="checkbox"/>	<input type="checkbox"/>
6	<input type="checkbox"/>	<input type="checkbox"/>	<input checked="" type="checkbox"/>	<input type="checkbox"/>	21	<input checked="" type="checkbox"/>	<input type="checkbox"/>	<input type="checkbox"/>	<input type="checkbox"/>
7	<input type="checkbox"/>	<input type="checkbox"/>	<input type="checkbox"/>	<input checked="" type="checkbox"/>	22	<input type="checkbox"/>	<input checked="" type="checkbox"/>	<input type="checkbox"/>	<input type="checkbox"/>
8	<input type="checkbox"/>	<input checked="" type="checkbox"/>	<input type="checkbox"/>	<input type="checkbox"/>	23	<input type="checkbox"/>	<input type="checkbox"/>	<input checked="" type="checkbox"/>	<input type="checkbox"/>
9	<input checked="" type="checkbox"/>	<input type="checkbox"/>	<input type="checkbox"/>	<input type="checkbox"/>	24	<input type="checkbox"/>	<input type="checkbox"/>	<input type="checkbox"/>	<input checked="" type="checkbox"/>
10	<input type="checkbox"/>	<input type="checkbox"/>	<input checked="" type="checkbox"/>	<input type="checkbox"/>	25	<input checked="" type="checkbox"/>	<input type="checkbox"/>	<input type="checkbox"/>	<input type="checkbox"/>
11	<input checked="" type="checkbox"/>	<input type="checkbox"/>	<input type="checkbox"/>	<input type="checkbox"/>	26	<input checked="" type="checkbox"/>	<input type="checkbox"/>	<input type="checkbox"/>	<input type="checkbox"/>
12	<input type="checkbox"/>	<input type="checkbox"/>	<input type="checkbox"/>	<input checked="" type="checkbox"/>	27	<input type="checkbox"/>	<input checked="" type="checkbox"/>	<input type="checkbox"/>	<input type="checkbox"/>
13	<input checked="" type="checkbox"/>	<input type="checkbox"/>	<input type="checkbox"/>	<input type="checkbox"/>	28	<input type="checkbox"/>	<input type="checkbox"/>	<input checked="" type="checkbox"/>	<input type="checkbox"/>
14	<input checked="" type="checkbox"/>	<input type="checkbox"/>	<input type="checkbox"/>	<input type="checkbox"/>	29	<input type="checkbox"/>	<input checked="" type="checkbox"/>	<input type="checkbox"/>	<input type="checkbox"/>
15	<input type="checkbox"/>	<input type="checkbox"/>	<input type="checkbox"/>	<input checked="" type="checkbox"/>	30	<input type="checkbox"/>	<input type="checkbox"/>	<input checked="" type="checkbox"/>	<input type="checkbox"/>

One mark have been allotted to every candidate for question no 17.

**All alternative solutions have been given due consideration****SECTION B****QUESTION 31****A.**

- I. Total fluid if 70 % of body weight i.e. 70% of 70Kg = 49 Kg  
 Blood is 8% of the total fluid i.e. 8% of 49 kg = 3.92 kg  
 Converting kg into volume-  $3920/1060 = 3.698$  litres
- II. DNA in White blood cells:  $7000 \times 1000 \times 1000 \times 3.69 \times 46$
- III. Weight of albumin = 7% of 3.92 =  $0.2744 \times 58\% = .159$ kg  
 $66000 \text{ g} = 1 \text{ mole}$   
 $159 \text{ g} = 159/66000 \text{ moles}$

**B.**

Label	Composition of blood (choose between oxygenated or deoxygenated)	Direction of flow (choose between away from or towards the heart)
1	Oxygenated	Away from
2	Deoxygenated	Away from
3	Oxygenated	towards
4	Deoxygenated	towards

## QUESTION 32

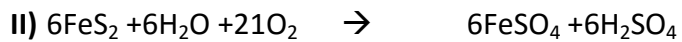

..... Or

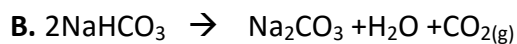
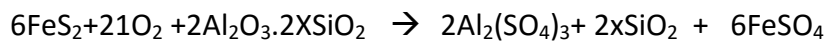

2x84

22.4 L

Amt of  $\text{NaHCO}_3$  equivalent to 56 mL of  $\text{CO}_2$  at NTP =  $(56 \times 168) / 22400 = 0.42\text{g}$

Equivalent of  $\text{NaHCO}_3$  present =  $0.42 / 84 = 0.005$  or 5 milli eq.

The amt. of HCl consumed by  $\text{NaHCO}_3$  and  $\text{Na}_2\text{CO}_3$  in the mixture = 30.5 mL of 1N HCl = 0.0305 equivalents or 30.5 milli eq.

The amt. of HCl consumed by  $\text{Na}_2\text{CO}_3 = 30.5 - 5 = 25.5$  m.e.

Hence the amt. of  $\text{Na}_2\text{CO}_3$  present =  $25.5 \times 53 \times 10^{-3} \text{g} = 1.35 \text{g}$

Thus amt. of NaCl in 3g of the mixture =  $3 - 0.42 - 1.35 = 1.23$

% Of NaCl =  $41\% = (1.23 \times 100) / 3$

## QUESTION 33

I) Sample 1)  $2\text{mg of CaSO}_4 = 2 \times 10^{-3} \text{ g of CaSO}_4 = 2 \times 10^{-3} / 136 = 1.5 \times 10^{-5} \text{ mol of CaSO}_4$   
 $1 \text{ mol of CaSO}_4 = 1 \text{ mol of CaCO}_3 = 100 \text{ g of CaCO}_3$

Therefore  $1.5 \times 10^{-5} \text{ mol of CaSO}_4 = 1.5 \times 10^{-5} \times 100 = 1.5 \times 10^{-3} \text{ g of CaCO}_3$

Thus,  $1000 \text{ g of water contains CaSO}_4$  equivalent to  $1.5 \times 10^{-3} \text{ g of CaCO}_3$

$10^6 \text{ g (one million) of water contains} = [(1.5 \times 10^{-3}) / 1000] \times 10^6 = 1.5 \text{ g of CaCO}_3$

**Or  $[(2 \times 100) / 136] = 1.5 \text{ g of CaCO}_3$  (direct method)**

$0.5 \text{ mg of MgCl}_2 = 5 \times 10^{-4} \text{ g of MgCl}_2 = 5 \times 10^{-4} / 95 = 0.053 \times 10^{-4} \text{ mol of MgCl}_2$

$1 \text{ mol of MgCl}_2 = 1 \text{ mol of CaCO}_3 = 100 \text{ g of CaCO}_3$

$0.053 \times 10^{-4} \text{ mol of MgCl}_2 = 0.053 \times 10^{-4} \times 100 = 0.053 \times 10^{-2} \text{ g of CaCO}_3$

$10^6 \text{ g (one million) of water contains} = [(0.053 \times 10^{-2}) / 1000] \times 10^6 = 0.53 \text{ g of CaCO}_3$

**Or  $[(0.5 \times 100) / 95] = 0.53 \text{ g of CaCO}_3$  (direct method)**

Hence degree of hardness of sample 1 is  $1.5 + 0.53 = 2.03 \text{ ppm}$

Sample 2)  $3 \text{ mg of MgSO}_4 = 3 \times 10^{-3} \text{ g of MgSO}_4 = 3 \times 10^{-3} / 120 = 2.5 \times 10^{-5} \text{ mol of MgSO}_4$

$1 \text{ mol of MgSO}_4 = 1 \text{ mol of CaCO}_3 = 100 \text{ g of CaCO}_3$

Therefore  $2.5 \times 10^{-5} \text{ mol of MgSO}_4 = 2.5 \times 10^{-5} \times 100 = 2.5 \times 10^{-3} \text{ g of CaCO}_3$

Thus,  $1000 \text{ g of water contains MgSO}_4$  equivalent to  $2.5 \times 10^{-3} \text{ g of CaCO}_3$

$10^6 \text{ g (one million) of water contains} = [(2.5 \times 10^{-3}) / 1000] \times 10^6 = 2.5 \text{ g of CaCO}_3$

Hence degree of hardness of sample 2 =  $2.5 \text{ ppm}$

**Or  $[(3 \times 100) / 120] = 2.5 \text{ g of CaCO}_3$  (direct method)**

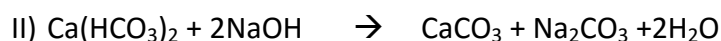

(Any one reaction either with Calcium or Magnesium)

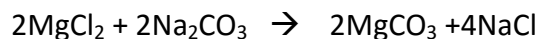
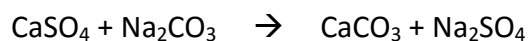

(Any two reactions either with sulphate or chloride of Calcium or Magnesium)

**QUESTION 34**

**A.** The evaporation of water through the pores causes decrease in the temperature. Let  $m$  kg be the mass of the water evaporated.

Heat of vaporization =  $42000 \text{ J/mol} = 7000/3 \text{ J/g} = (7/3) \times 10^6 \text{ J/kg}$

$(20 - m) \times 4200 \times 5 = m(7 \times 10^6 / 3) \therefore (20 - m)21 = 7000m/3$

$\therefore 420 - 21m = 7000m/3 \therefore 1260 - 63m = 7000m \therefore 1260 = 7063m \therefore m \cong 0.18 \text{ kg (or, 0.17 kg)}$

**B.** Voltage across LED for 625 nm (red) light =  $1250/625 = 2 \text{ V}$ .

Remaining voltage (from 5 V) will be across the resistance.

$\therefore V_{res_{red}} = 5 - 2 = 3 \text{ V}$ . Current through LED, i. e. through circuit is 20 mA (for significant brightness).

$$\therefore R_{red} = \frac{3}{20 \times 10^{-3}} = 150 \Omega$$

Out of this  $40 \Omega$  is a fixed resistance. Thus maximum additional resistance of  $110 \Omega$  will be 625 nm light.

Voltage across LED for 500 nm (green) light =  $1250/500 = 2.5 \text{ V}$ .

Remaining voltage (from 5 V) will be across the resistance.

$\therefore V_{res_{green}} = 5 - 2.5 = 2.5 \text{ V}$ . Current through LED, i. e. through circuit is 20 mA (for significant brightness).

$$\therefore R_{red} = \frac{2.5}{20 \times 10^{-3}} = 125 \Omega$$

Out of this  $40 \Omega$  is a fixed resistance. Thus minimum additional resistance of  $85 \Omega$  will be 500 nm light.

Range of rheostat resistance is  $85 \Omega$  to  $110 \Omega$ .

**QUESTION 35**

- I) c)Variation in character should be available in the population
- II) b)Bar eye is a mutant character because it is found rarely in the nature
- III) b)Bb OR c)bb
- IV) d)Adult
- V) a) red, round-eyed
  - b) Yes
  - c) It shows a 9:3:3:1 ratio, a hallmark of independent assortment

**QUESTION 36**

- A.** Current through  $8 \Omega$  resistance after removing  $R$  is  $5/20 = \frac{1}{4}$  A.  $\therefore$  the p. d. across  $8 \Omega$  resistance is  $2$  V.  $\therefore$  in the original circuit, the p. d. across  $6 \Omega$  resistance is  $3$  V.  $\therefore$  the current through it is  $\frac{1}{2}$  A.  $\therefore$  the current through  $R$  is  $\frac{1}{4}$  A and p. d. across it is  $2$  V  $\therefore R = 8 \Omega$
- B.** Current rating  $3600$  mAh means if we draw a constant current of  $3.6$  A, the battery will last for  $1$  hour. In the present case it lasts for  $24$  hours.  $\therefore I = 3.6/24 = 0.15$  A.

$V = 3.6$  V and  $I = 0.15$  A. Thus equivalent resistance of the circuit in the first case is  $R_x = 3.6/0.15 = 24 \Omega$ .

The equivalent circuit is given besides.  $R_x$ , the resistance between A and C is  $= 3R/2$ . Thus,  $R = 16 \Omega$

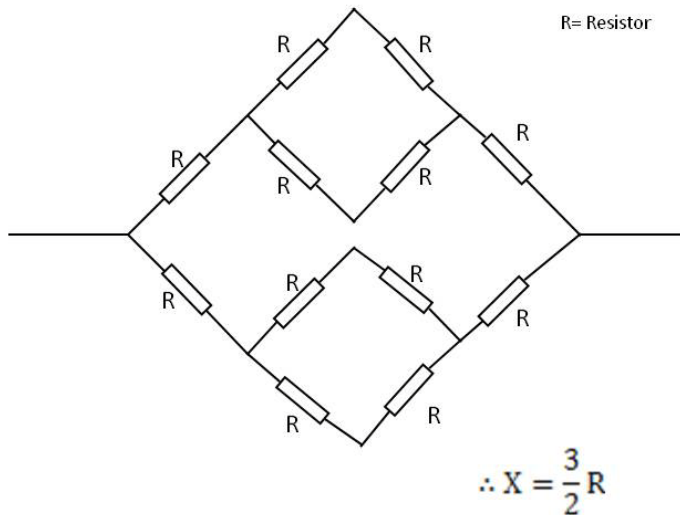

Part 2) When used across DC, then the points M, N and O are equipotential due to symmetry, the circuits can be reduced to following and  $(R_x)_2 = 5R/4 = 20 \Omega$ .

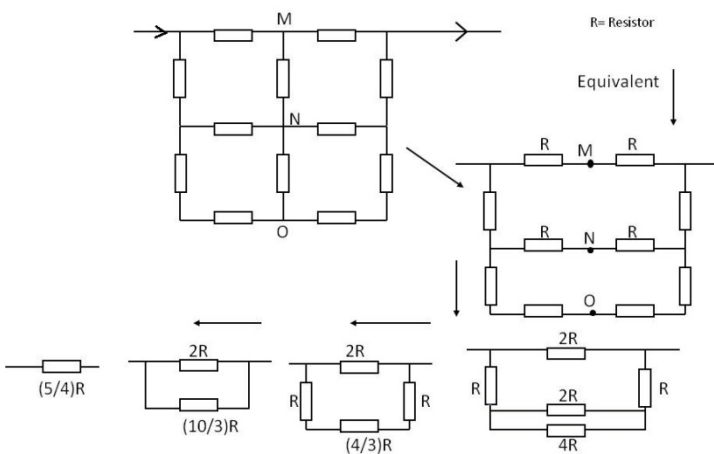

Total energy is constant.  $\therefore V^2 t / R_x = \text{constant}$ . Battery voltage  $3.6$  V is the same.  $\therefore t$  is proportional to  $R_x$ .  $\therefore t_2 = 20$  hours.

**QUESTION 37**

**A.**

- I) c)3n
- II) a)Mitochondrial DNA only
- III) a) To retain large quantity of cytoplasm in the oocyte.
- IV) b) Primary oocytes are already produced in the ovary when a girl is born.

**B.**

- I) c)One male and two females all contributing genetically
- II) a) F
  - b) T
  - c) T
  - d) T
  - e) F

**QUESTION 38**

**A.** The answer is NO. If a student writes answer YES and gives the angles of emergence, it is not correct and no credit will be given. For answer NO, the sector is given in terms of angles  $\alpha$  and  $\beta$ .

$$\sqrt{3} = \frac{\sin 60^\circ}{\sin r} = \mu \therefore r = 30^\circ, \text{ for all the rays.}$$

$$\frac{1}{\mu} = \frac{1}{\sqrt{3}} = \sin i_c \therefore i_c = \sin^{-1}\left(\frac{1}{\sqrt{3}}\right) \cong 35^\circ$$

As seen from the figure, the rays through glass just emerge (grazing emergence) at A and B.

From  $\triangle ACD$ ,  $\alpha = 180 - 60 - 35 = 85^\circ$

For  $\triangle BCE$ ,  $\beta = \angle ACB$  is exterior angle for  $\angle CEB$  and  $\angle EBC$ .  $\therefore \beta = 120 + 35 = 155^\circ$

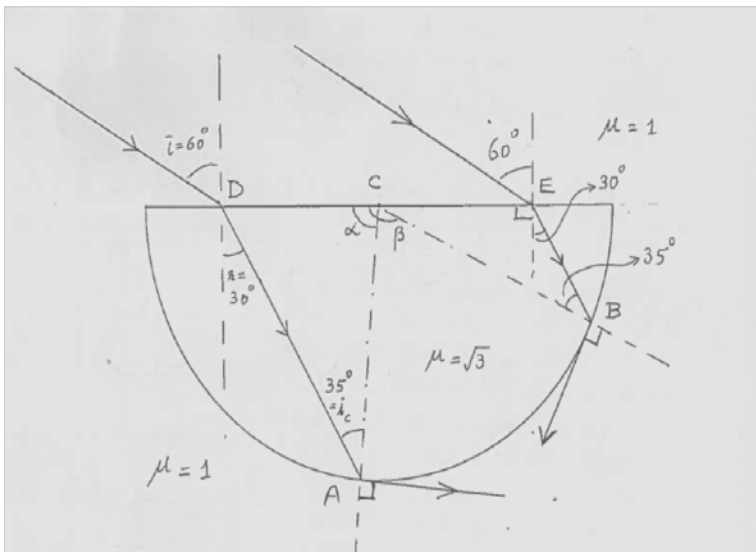

Diagram given may not be to the

scale.

B.  $\lambda = 20 \text{ g/m} = 0.02 \text{ kg/m}$ ,  $g = 10 \text{ m/s}^2$

Distance $x$ in metre from the free end	Tension $T = mg$ in newton at that distance	$\frac{T}{\lambda}$ in $\text{m}^2\text{s}^{-2}$	$v = \sqrt{\frac{T}{\lambda}}$ in $\text{m/s}$
1	0.2	10	3.16
2	0.4	20	4.47
3	0.6	30	5.48
4	0.8	40	6.32
5	1.0	50	7.07
6	1.2	60	7.75

Final ans 5.9 m/s

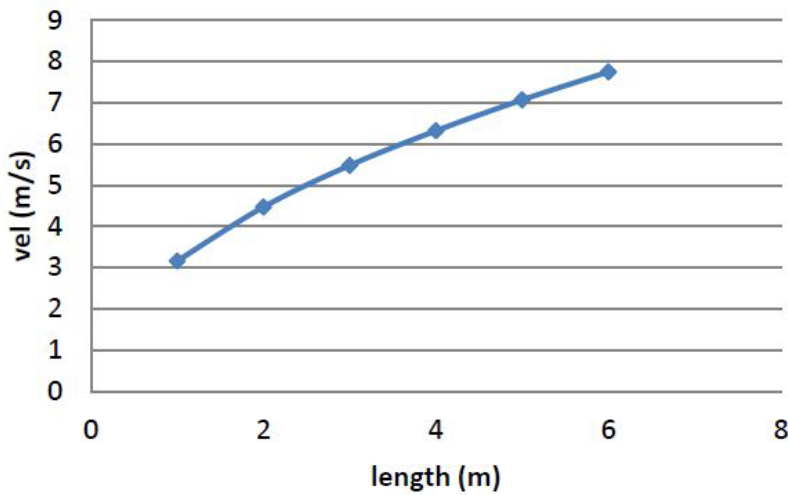



**QUESTION 39**

A. Given C: H :: 10.5:1 Total : 11.5

For molecular weight of hydrocarbon in gas phase

$$PV = \frac{W}{M} RT$$

$$1 \times 1 = \frac{2.8}{M} 0.0821 \times 400 \quad M=92$$

11.5g of hydrocarbon has 1.0g of hydrogen

$$92. \text{ g of hydrocarbon will have } \frac{92}{11.5} \times \frac{1.0}{1} = 8 \text{ g of hydrogen}$$

Hydrocarbon will have  $92 - 8 = 84$  g of carbon

8 g of hydrogen = 8 atoms of hydrogen

$$84 \text{ g of carbon} = \frac{84}{12} = 7 \text{ atoms of carbon}$$

Molecular formula:  $C_7H_8$

B.

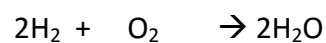
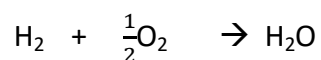

Volume before reaction      a      b

Volume after reaction      (a-2b)      0

$$a+b = 40$$

$$a-2b = 10$$

$$a = 30 \text{ ml}, \quad b = 10 \text{ ml}$$

$$\text{Mole \% of hydrogen} = \text{Volume \% of hydrogen} = \frac{30}{30+10} \times 100 = 75$$

Ans : 75 %.

**QUESTION 40**

- I.     a) False  
       b) False  
       c) True
  
- II.    (i) chloroplast, (ii) photosynthesis (iii) decreases (iv) endosmosis (v) higher (vi) lower (vii) increase
  
- III.   c) Decrease in the rate of nitrogen fixation.
  
- IV.    a) The environment is hypertonic with respect to cell A.
  
- V.     c) Water will flow out from the guard cell
  
- VI.    a) Stoma remains in state 1 for an extended period of time.

**QUESTION 41**

$$3.5 \text{ hrs} = 3.5 \times 60 = 210 \text{ min}$$

$$\text{Amount of air inhaled} = 210 \times 8 = 1680 \text{ litres}$$

20 % of oxygen present in air ,

$$\text{Amount of oxygen in 1680 litres air} = \frac{1680 \times 20}{100} = 336 \text{ litres}$$

5% of it is consumed by the body at STP

$$\text{Amount of oxygen consumed by body in 3.5 hrs at STP} = \frac{336 \times 5}{100} = 16.8 \text{ litres}$$

$$22.4 \text{ litres} = 1 \text{ mole at STP}$$

$$\text{Hence 16.8 litres of oxygen at STP} = \frac{16.8}{22.4} = 0.75 \text{ mole}$$



$$1 \text{ Mole} \quad 6 \text{ Mole} \quad 6 \text{ Mole}$$

$$0.125 \text{ mole} \quad 0.75 \text{ mole} \quad 0.75 \text{ mole}$$

$$\text{Molecular mass of C}_6\text{H}_{12}\text{O}_6 = 72 + 12 + 96 = 180$$

$$0.125 \text{ mole of C}_6\text{H}_{12}\text{O}_6 = 0.125 \times 180 = 22.5 \text{ g}$$

$$\text{Amount of carbon dioxide exhaled in 3.5 hrs during the process} = 0.75 \text{ mole}$$

$$= 0.75 \times 44 (\text{molecular mass of CO}_2) = 33 \text{ g}$$

**QUESTION 42**

Volume of 40% of 1000 litre is 400 L whose mass is  $400 * 1000 * 1.1 \text{ g} = 440 \text{ kg}$

Volume of 60% of 1000 litre of  $\text{H}_2\text{O}$  has mass of  $600 * 1000 * 1 \text{ g} = 600 \text{ kg}$ .

Energy required to raise temperature from 4 to 10 degrees =  $440 * (10-4) * 4.25 + 600 * (10-4) * 4.15 = 11220 + 14940 = 26160 \text{ KJ}$

At 4 degrees the melting of  $\text{D}_2\text{O}$  will require  $L.m = 340 * 440 = 149600 \text{ KJ}$

Now change of water from 0 to 4 degrees requires

$$600 * (4-0) * 4.15 = 9960 \text{ KJ}$$

melting of ice requires  $600 * 330 = 198000 \text{ KJ}$

remaining energy = 3440 KJ

$$\text{sp heat} = 3440 / (4 * 440) = 1.95 \text{ kJ/kg/K}$$

At point A,  $Q = 198000 \text{ kJ}$ ,  $T = 0^\circ\text{C}$

At point B,  $Q = 211400 \text{ kJ}$ ,  $T = 4^\circ\text{C}$

At point C,  $Q = 361000 \text{ kJ}$ ,  $T = 4^\circ\text{C}$

At point D,  $Q = 387160 \text{ kJ}$ ,  $T = 10^\circ\text{C}$

